

11

ANTISHOCK SYSTEM

New bumper and plinth system produced in soft material, to be used in cold rooms, refrigerated storages and garages. Excellent anti-shock properties thanks to the material's elasticity.

Nuova linea di paracolpi e battiscopa in materiale morbido per celle frigo, magazzini refrigerati, garage. Ottima proprietà anti-urto grazie all'elasticità del materiale utilizzato.

Nouvelle gamme de lisses de protection et plinthes en matière souple pour les chambres froides, dépôts et garages. Excellente propriété anti-choc grâce à l'élasticité du matériel utilisé.

Antishock System

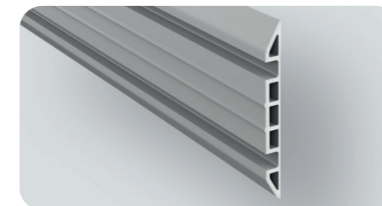
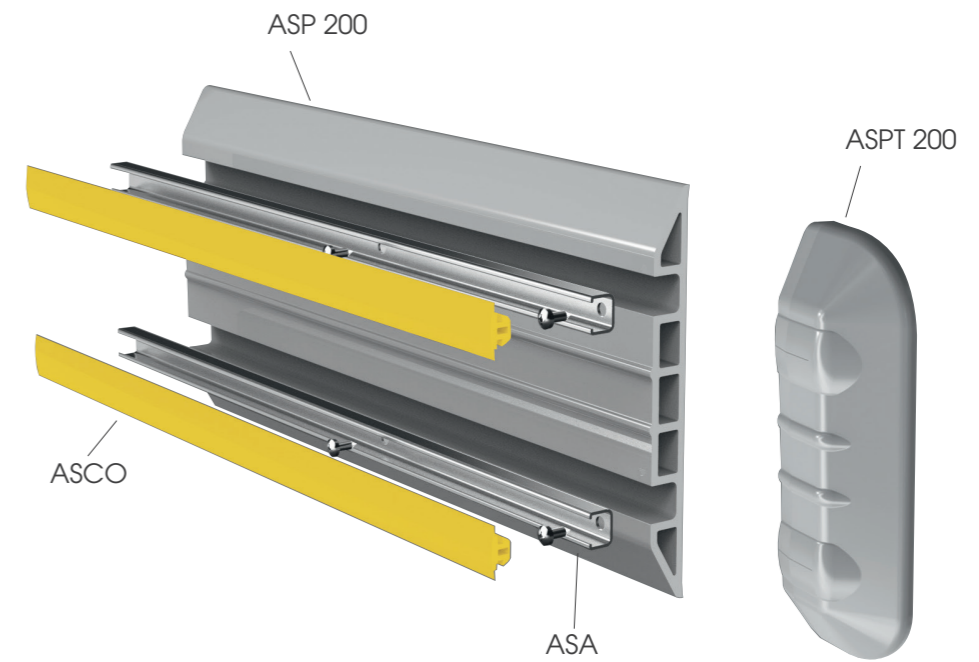

ASP 200



Packing **2 pz / box**
L = **4.000 mm**
Colour **B M**

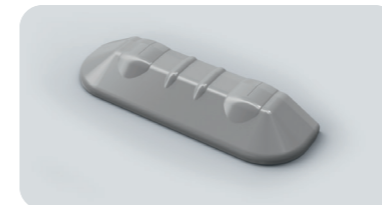
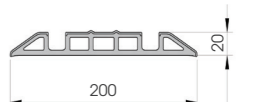

ASPT 200



Packing **10 pz / box**
Colour **B D**

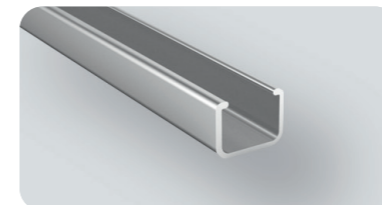
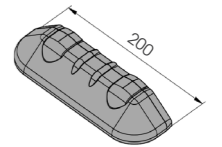

ASA

Material **aluminium**
Length **4.000 mm**
Packing **8 pz / bundle**

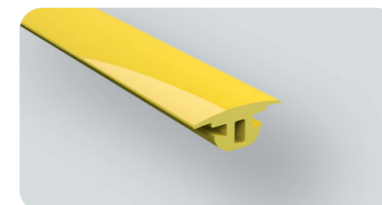
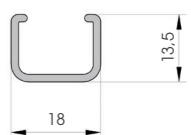

ASCO



Packing **2 pz / box**
L = **32.000 mm**
Colour **A B D G M**

