

27

BUMPER FLOOR

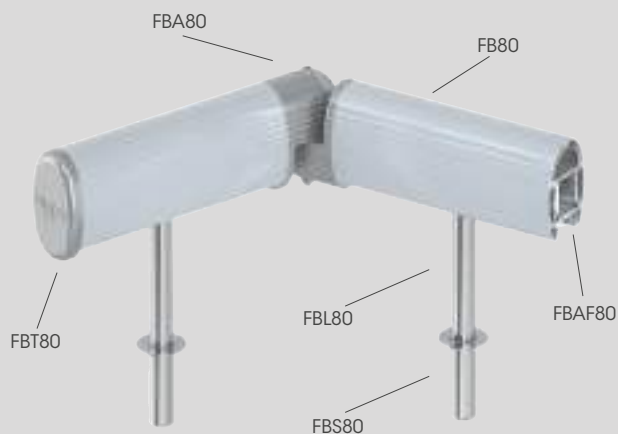

Spacer floor bumper to protect refrigerated cabinets and walls, fully equipped with corners and accessories necessary to assemble it.

Sistema di protezione distanziale a terra di banchi frigo e pareti, completo di curve e provvisto di accessori.

Système de protection au sol, épaisseur pour les vitrines réfrigérées et murs, pleine de courbes et équipé d'accessoires.



Bumper Floor



FB 80



Length **4.000 mm**
 Packing **6 pz / box**
 Colour **B**

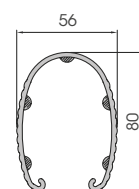

FBAF 80

Material **aluminium**
 Length **4.000 mm**
 Packing **6 pz / box**

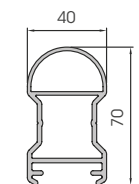

FBT 80

Equipped with screws

Material **aluminium**
 Packing **40 pz / box**

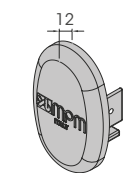

FBA 80

Equipped with screws

Material **aluminium**
 Packing **8 pz / box**

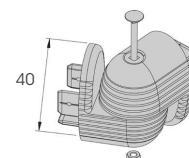

FBL 80

Equipped with screws

Material **stainless steel**
 Packing **20 pz / box**

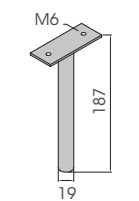

FBS 80

Material **stainless steel**
 Packing **20 pz / box**

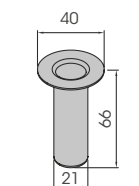

FR

Material **chemical anchor**
 Packing **1 pz / box**

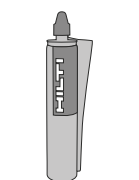

FBR

Material **steel**
 Length **400 mm**
 Packing **to be defined**

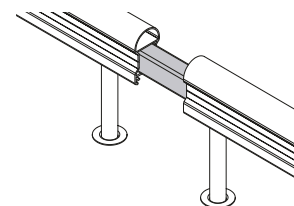

Bumper Floor



**S12
GALVANISED STEEL**



FB 90 2000

Length **2000 mm**
Packing **to be defined**
Colour **B**

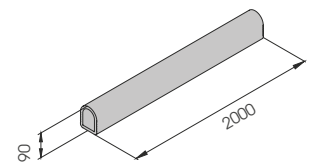

FBCO 90

Packing **2 pz / box**
Colour **B**

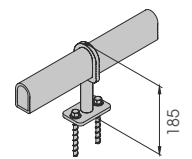

Equipped with accessories



FBT 90

Packing **2 pz / box**
Colour **D**

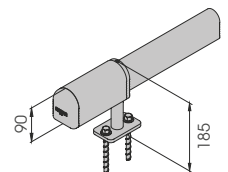

Equipped with accessories



FBA 90

Packing **2 pz / box**
Colour **B D**

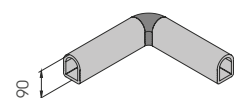

Bumper Floor

