

24 WHEEL SYSTEM

Complete system for sliding glass doors of refrigerated displays. Shockproof pvc profiles equipped with accessories to ensure good insulation and considerable energy saving. A lower rail is installed to allow the easy sliding opening and closing of doors.

Sistema completo per le porte scorrevoli a vetro degli armadi a muro. Profili realizzati in pvc antiurto completi di accessori che assicurano un buon isolamento e un notevole risparmio energetico. Dotato di sistema di scorrimento che rende agevole l'apertura e la chiusura delle porte.

Système complet pour les portes coulissantes en vitre de vitrines réfrigérées. Profilés en pvc anti-choc équipés d'accessoires pour assurer une bonne isolation et une économie d'énergie considérable. A rail inférieur est installé pour permettre le coulisement pratique de l'ouverture et de la fermeture des portes.

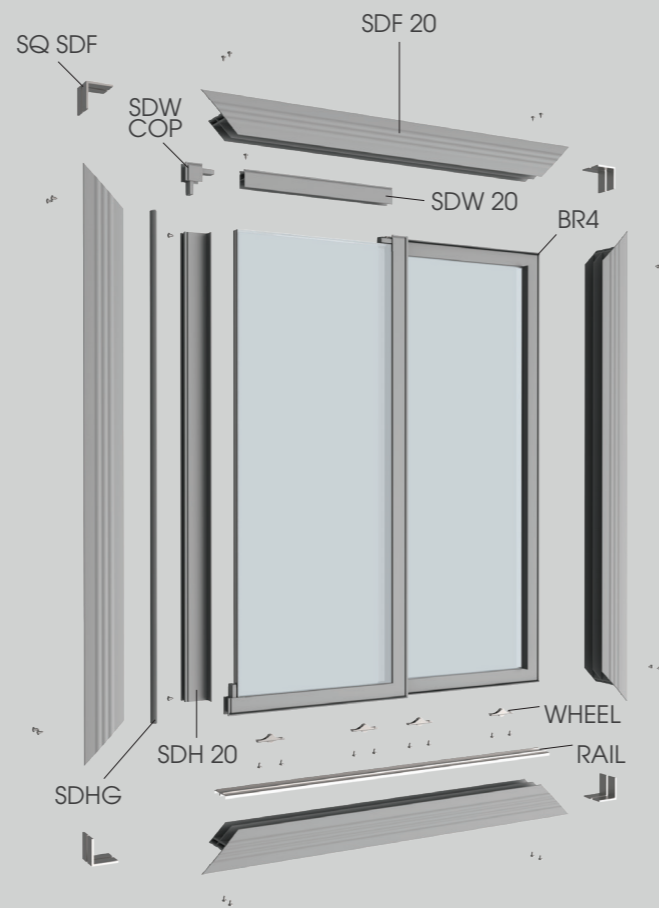

Wheel System

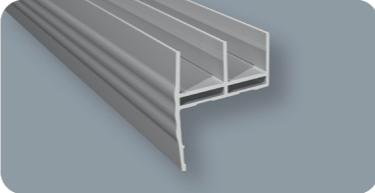
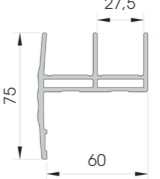
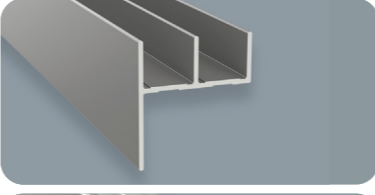
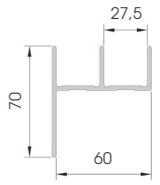
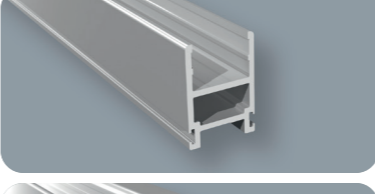
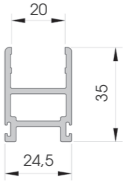
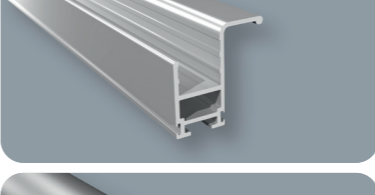
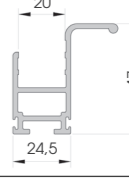
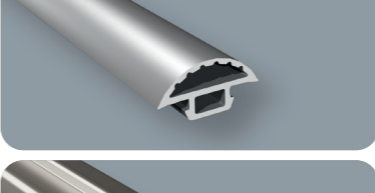
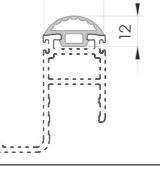
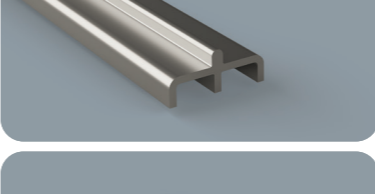
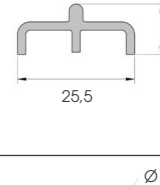
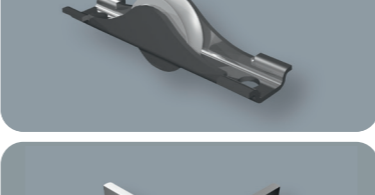
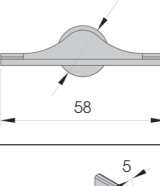
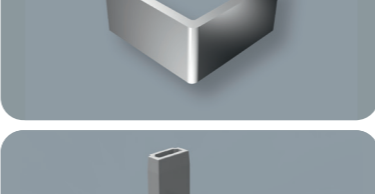
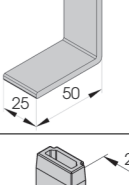
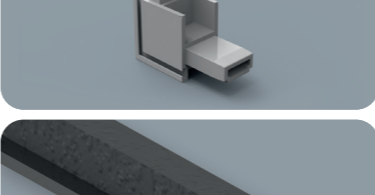
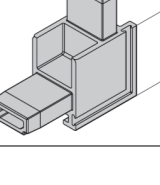
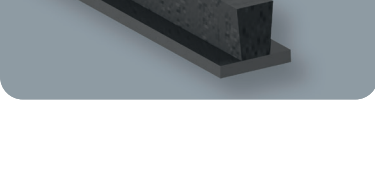
	SDF 20	Length Packing Colour	4.000 mm 5 pz / box B D	
	SDF 20 SHORT	Length Packing Colour	4.000 mm 5 pz / box B D	
	SDW 20	Length Packing Colour	4.000 mm 20 pz / box B D	
	SDH 20	Length Packing Colour	4.000 mm 12 pz / box B D	
	SDHG	Packing Colour	60 mt reel B D	
	RAIL 2	Material Length Packing	aluminium 3.000 mm 10 pz / bundle	
	WHEEL	Material Packing	steel 100 pz / box	
	SQ SDF To install with SDF	Material Packing	aluminium 100 pz / box	
	SDW COP To install with SDW 20 and SDH 20	Packing Colour	100 pz / box B D	
	BR 4.5 BR 9	Packing Colour	BR 4.5 1 pz / reel L 600 mt BR 9 1 pz / reel L 225 mt D	